

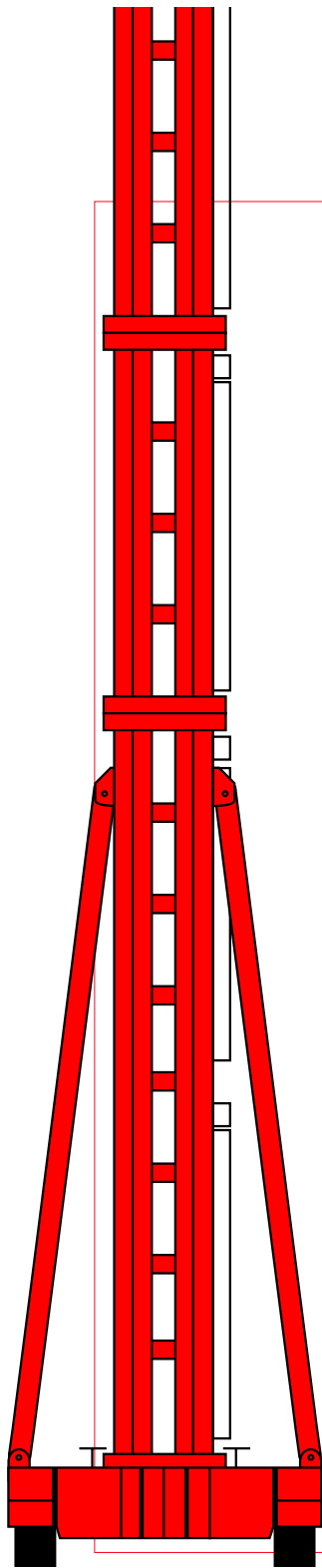

SCHOLPP
Der Systemdienstleister®



S-MG

SCHOLPP
Mechanisches
Hubgerüst

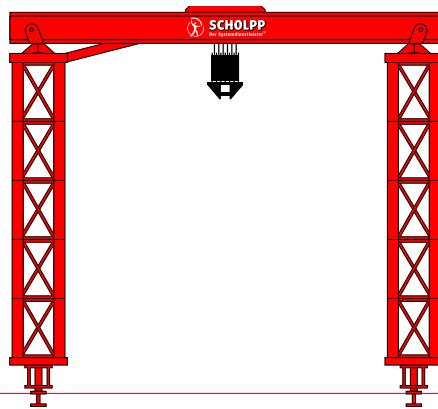

S-MG

Alu - Gerüst

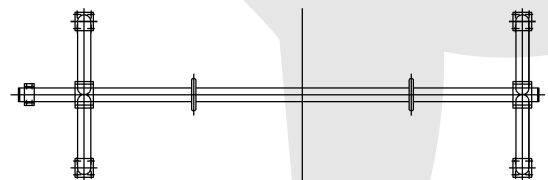
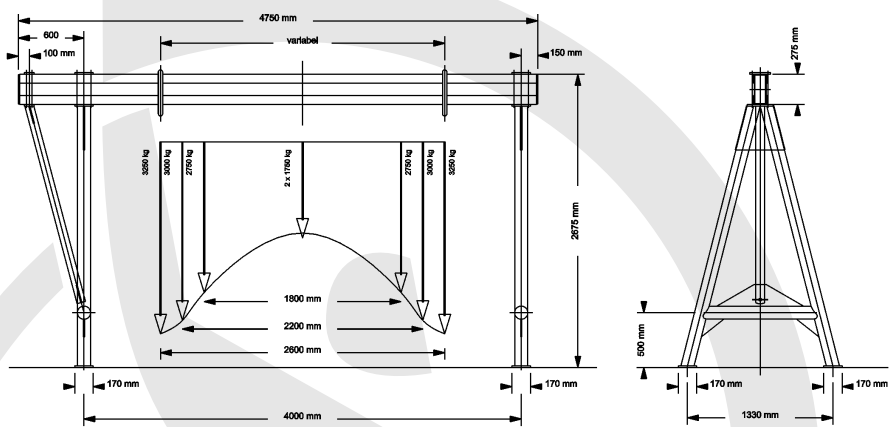

EINZELMASSEN - HAUPTTEILE

Feststütze	0,65 kN
Pendelstütze	0,47 kN
Kopfträger "C "	1,02 kN
Kopfträger "D "	0,59 kN

KOPFTRÄGER - LÄNGEN

"C "	4750 mm
"D "	2970 mm



SCHOLPP
Der Systemdienstleister®

Infoline 01805 - 75 85 99

500 kN (Seilzug)

Seite

2

Mechanisches Hubgerüst

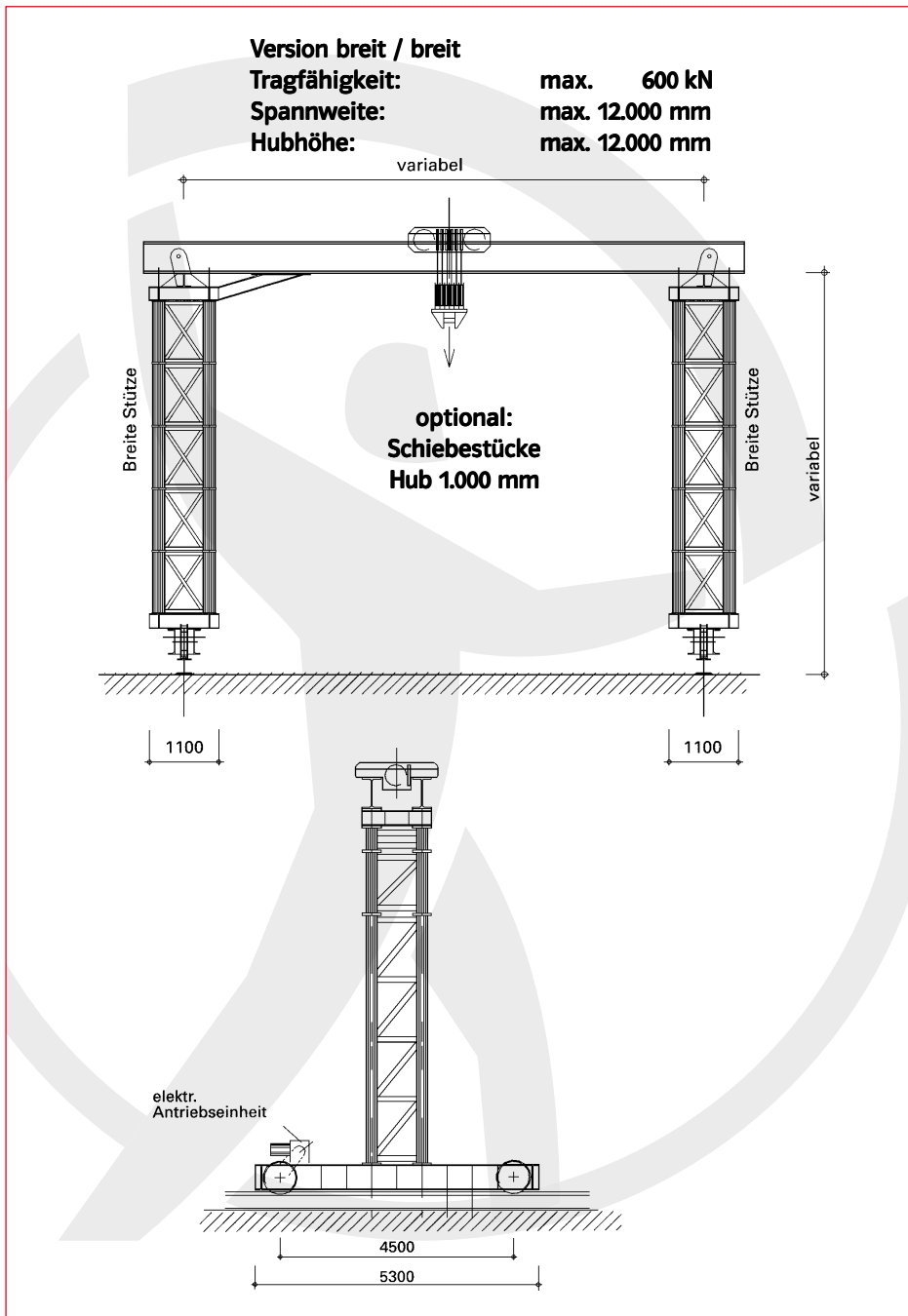

Mechanisches Hubgerüst	Seite	3	500 kN (Seilzug)
------------------------	-------	---	------------------

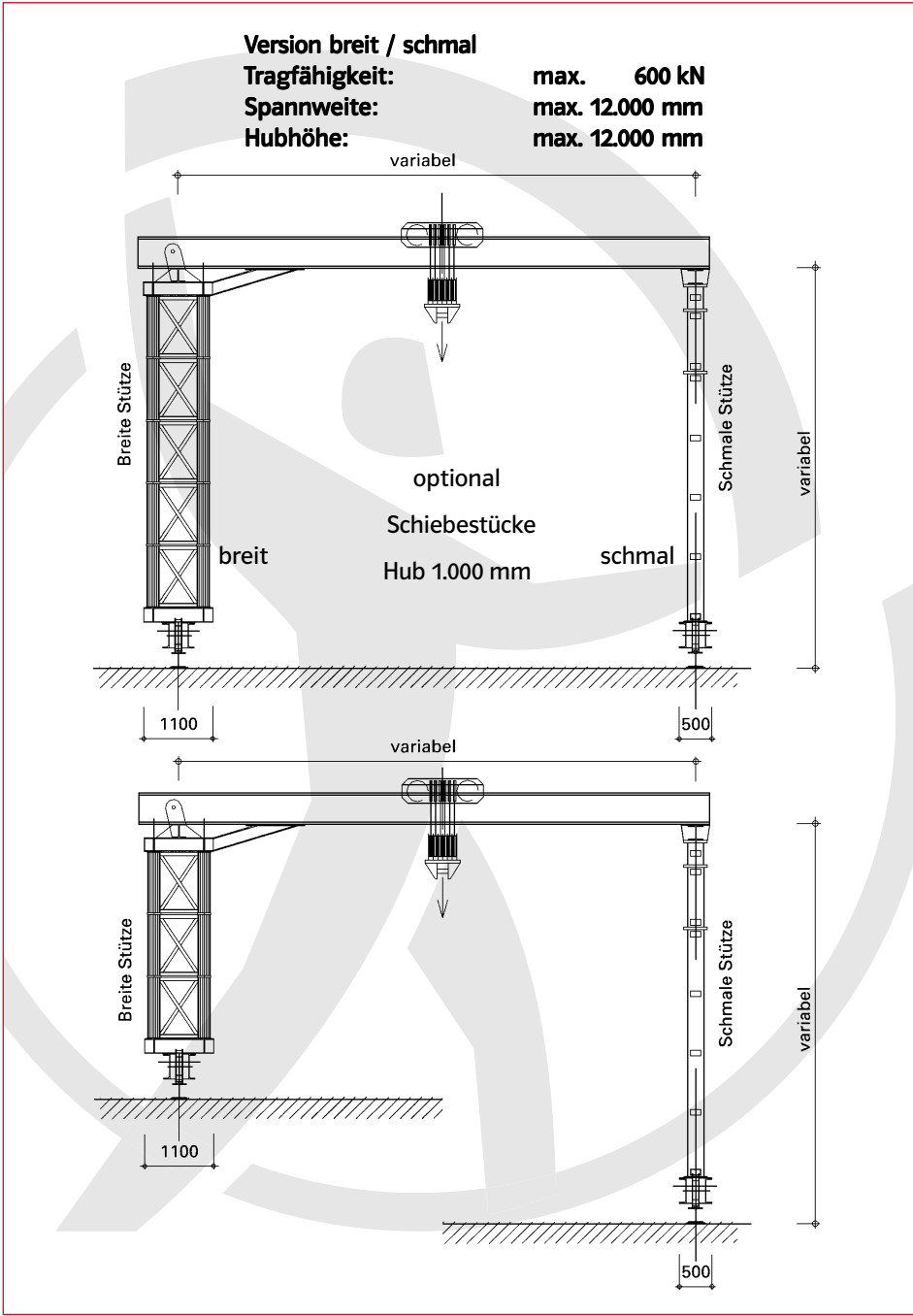

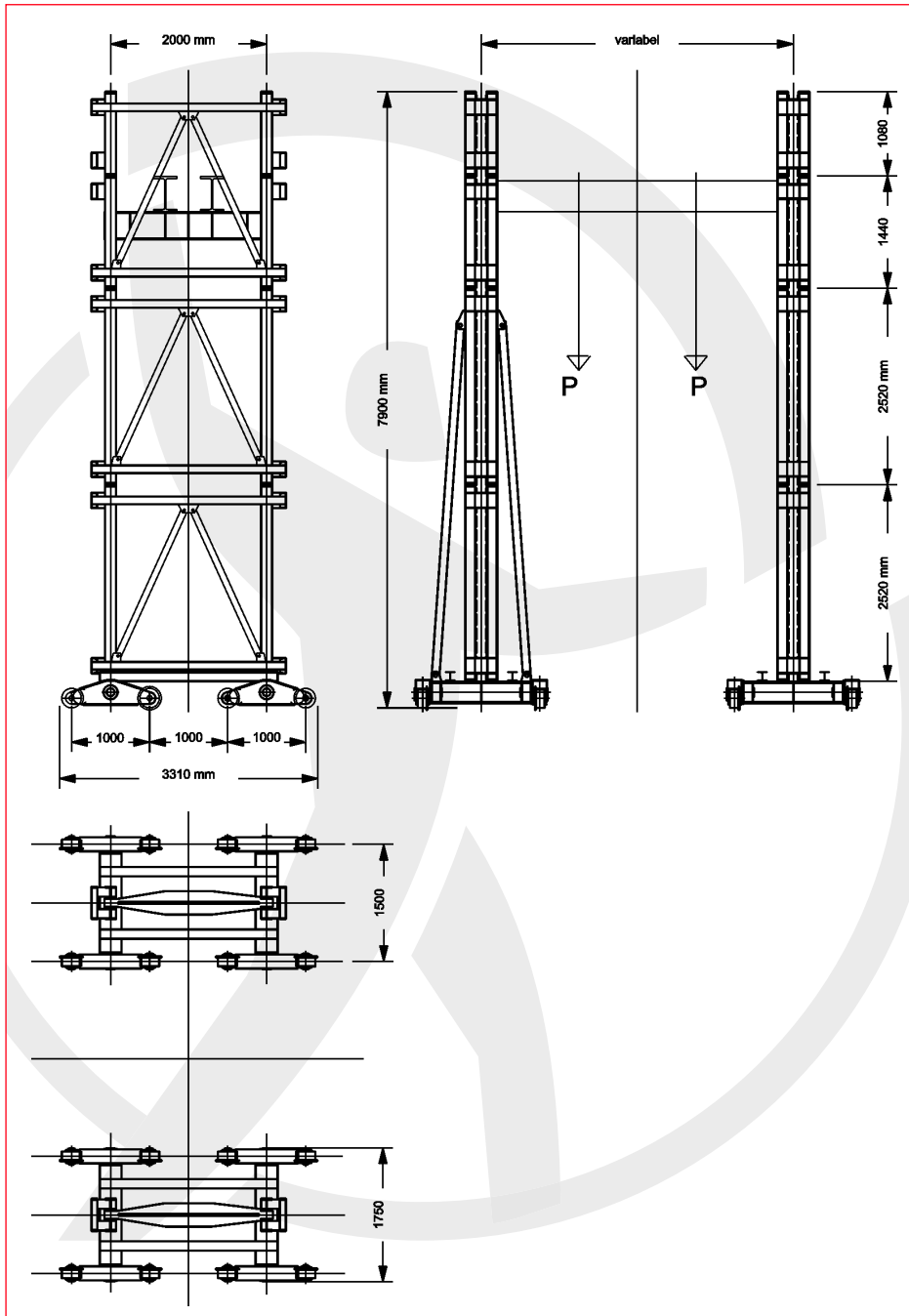

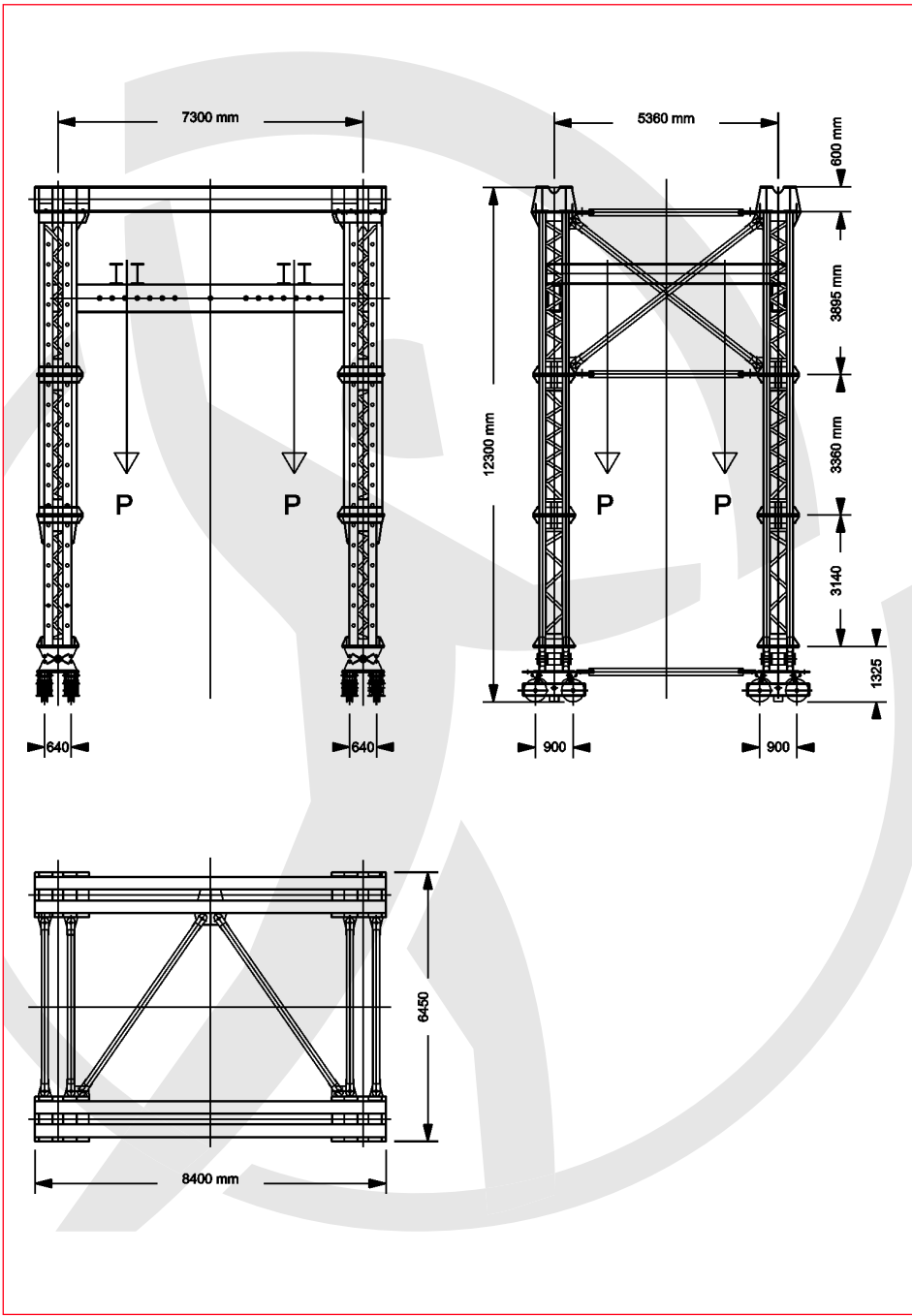

Stand 2007

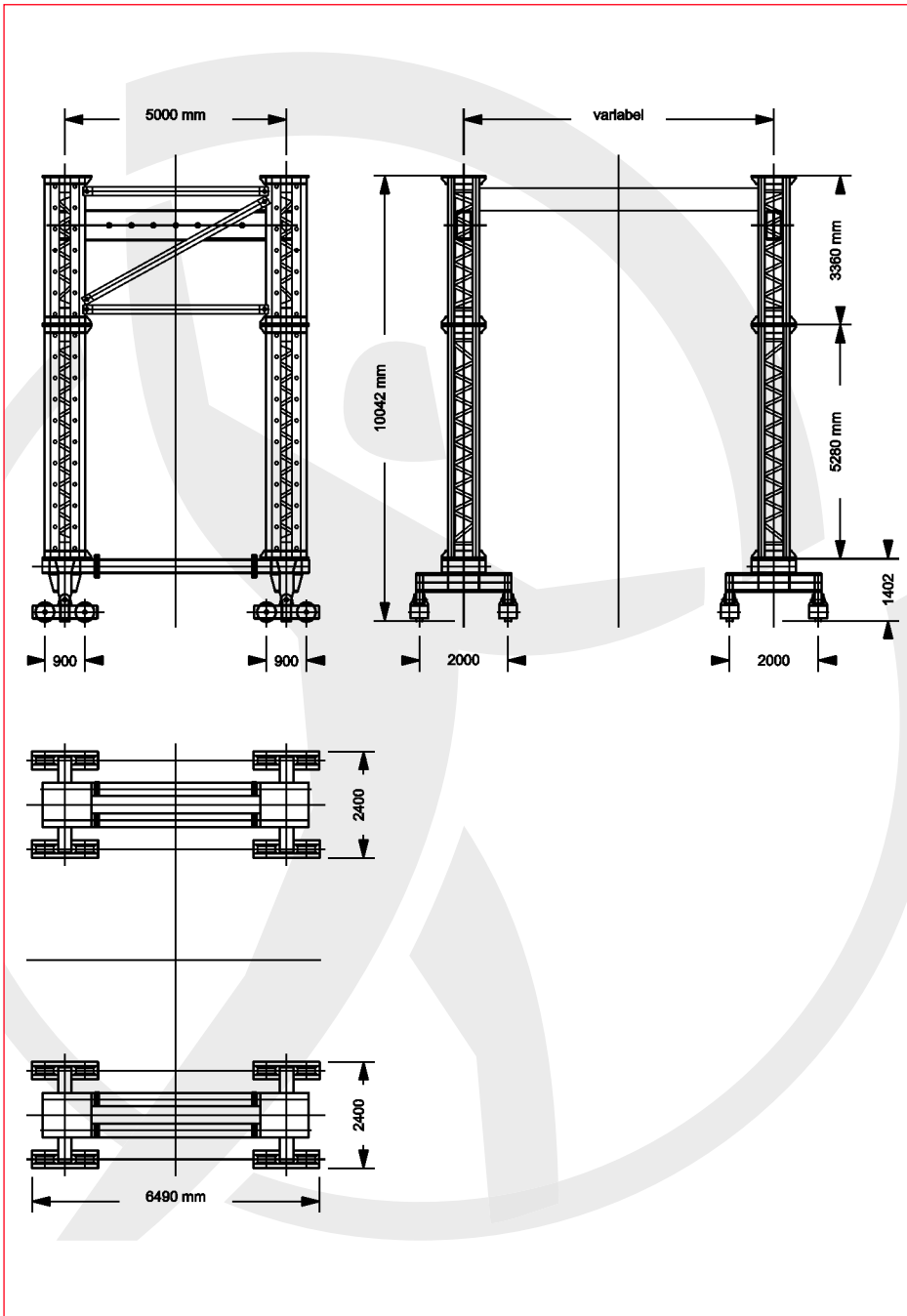



SCHOLPP
Der Systemdienstleister®



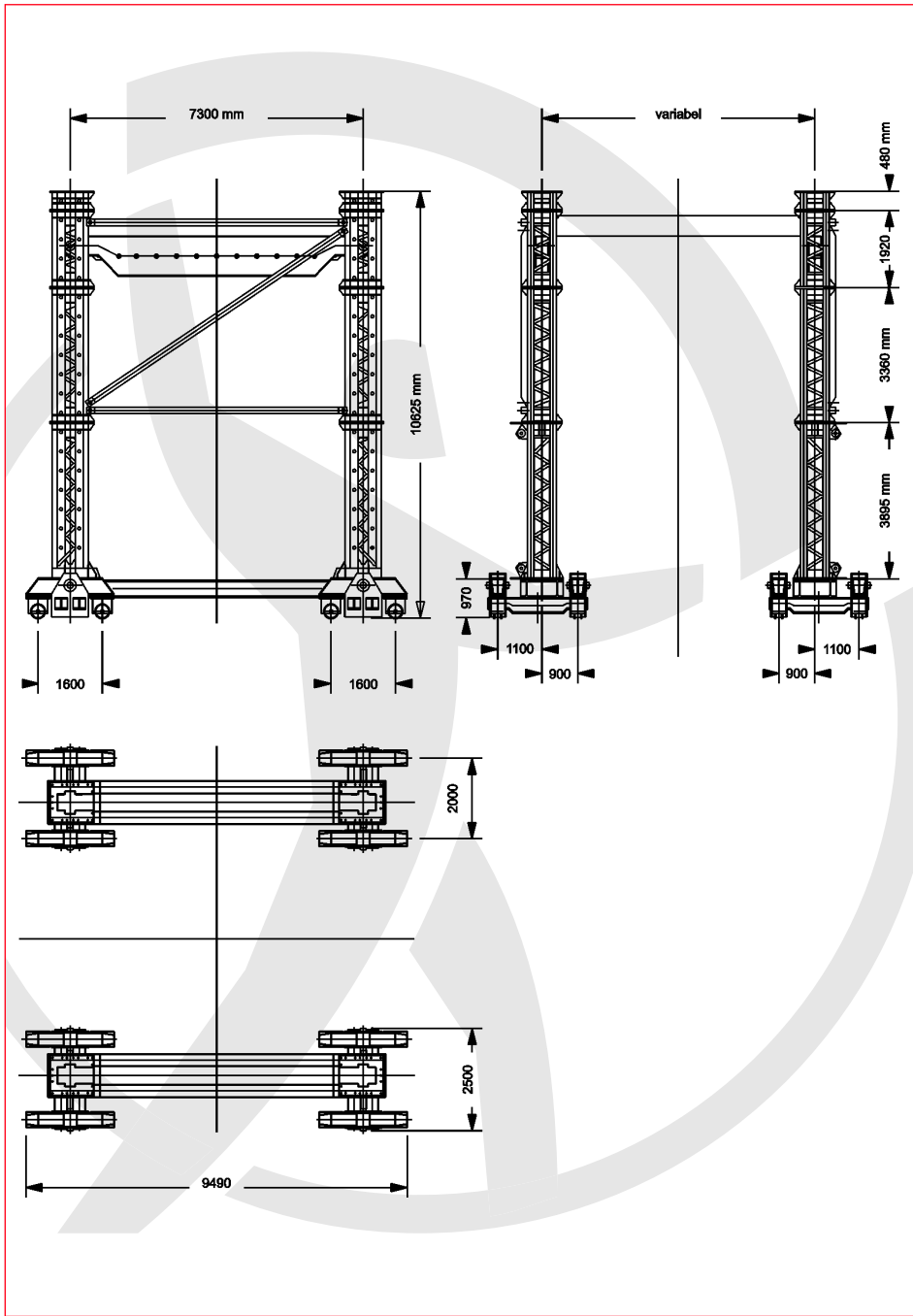

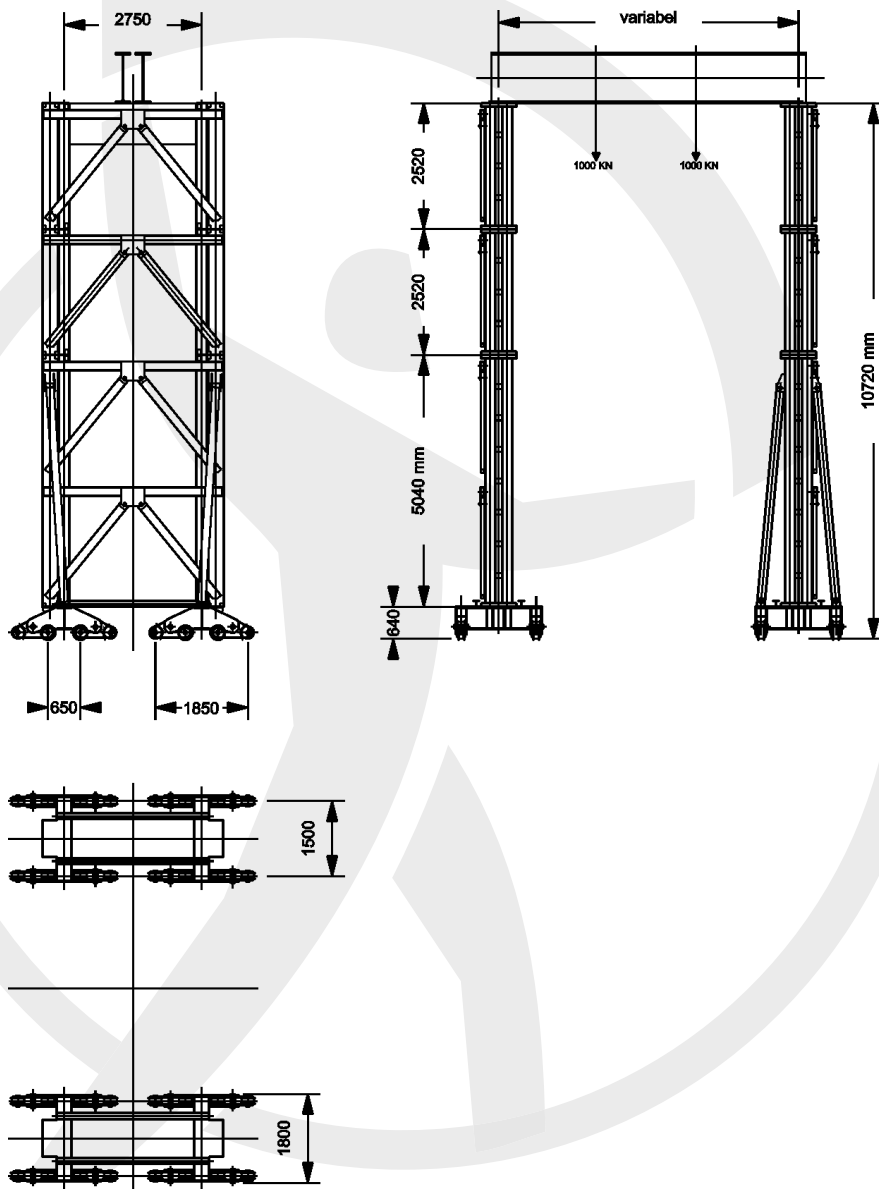

Infoline 01805 - 75 85 99

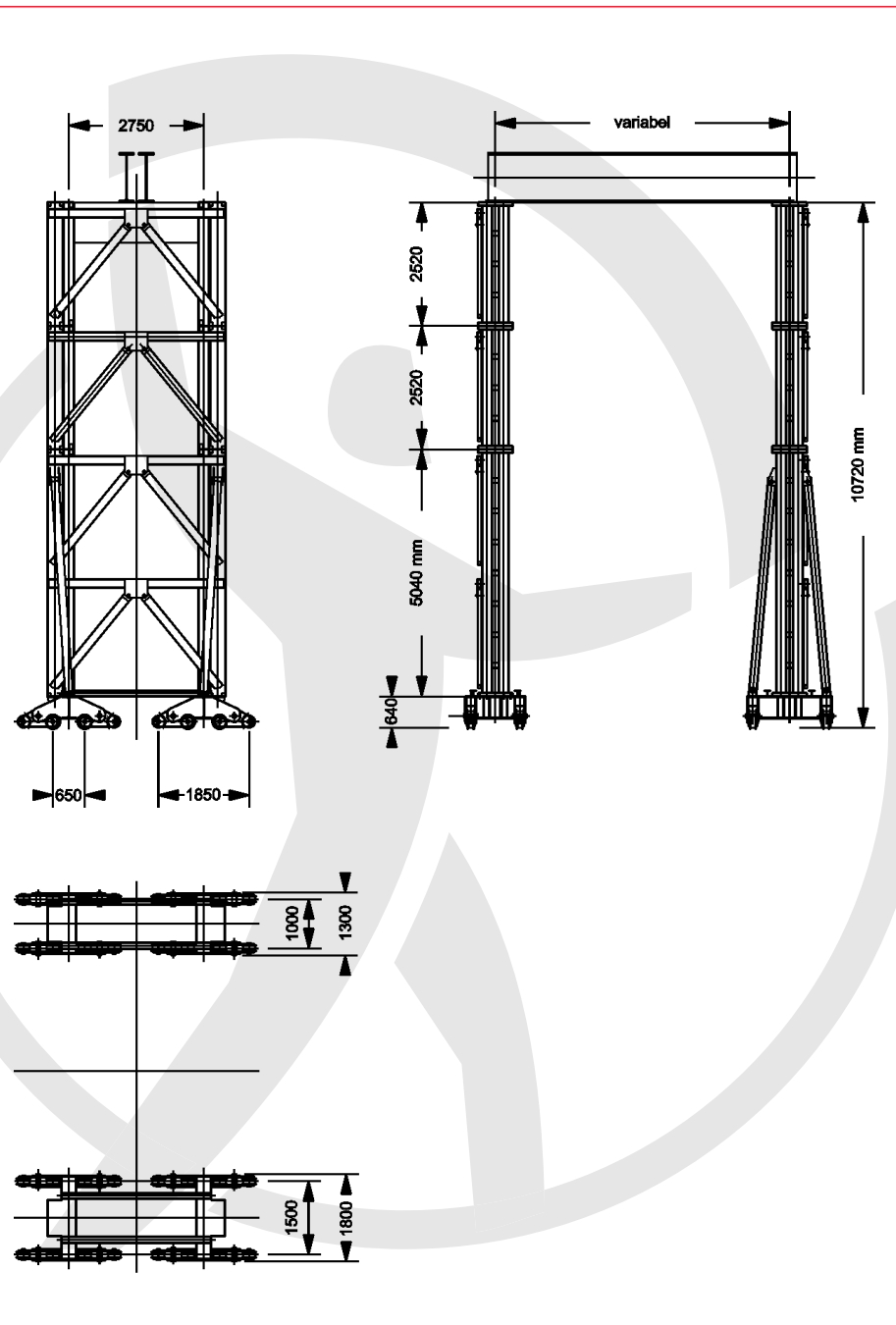



SCHOLPP
Der Systemdienstleister®

Infoline 01805 - 75 85 99

HG S 4000 kN / 6070

Seite

10

Mechanisches Hubgerüst

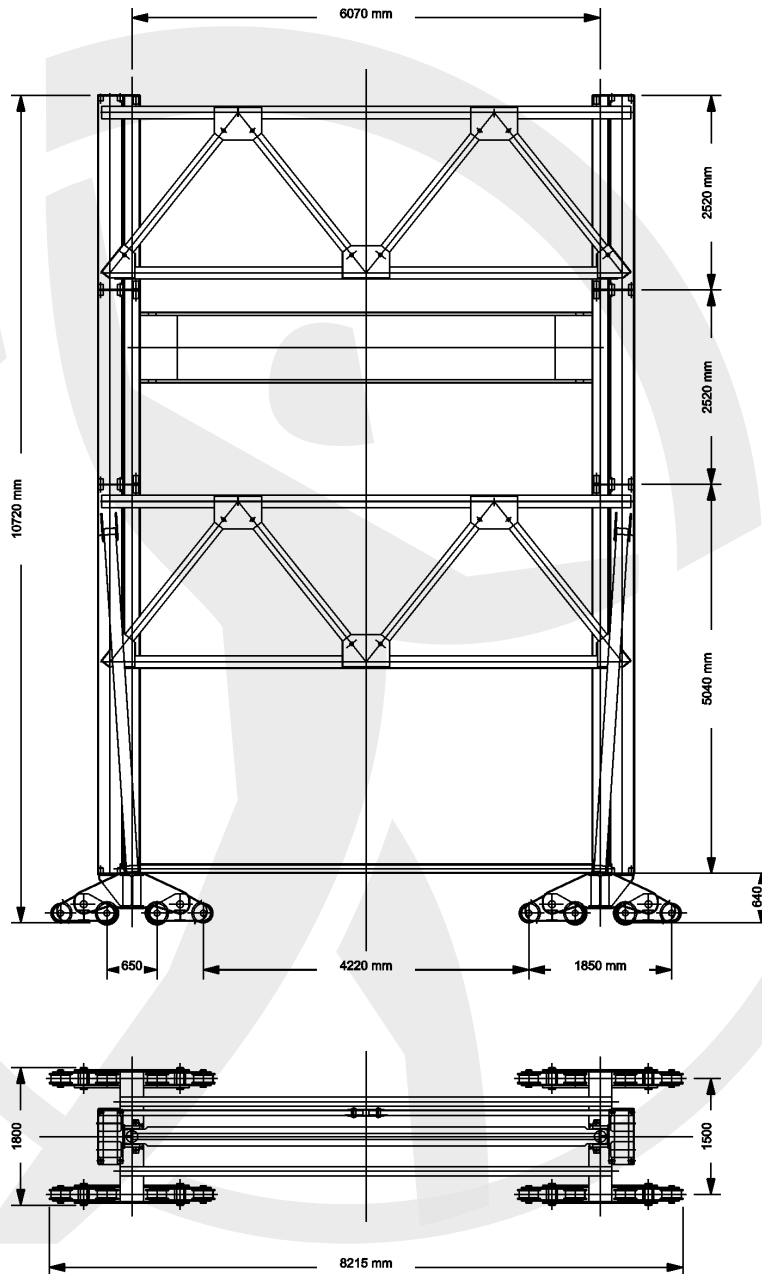

Stand 2007

Infoline 01805 - 75 85 99



SCHOLPP
Der Systemdienstleister®

Mechanisches Hubgerüst

Seite

11

HG S 4000 kN / 8200

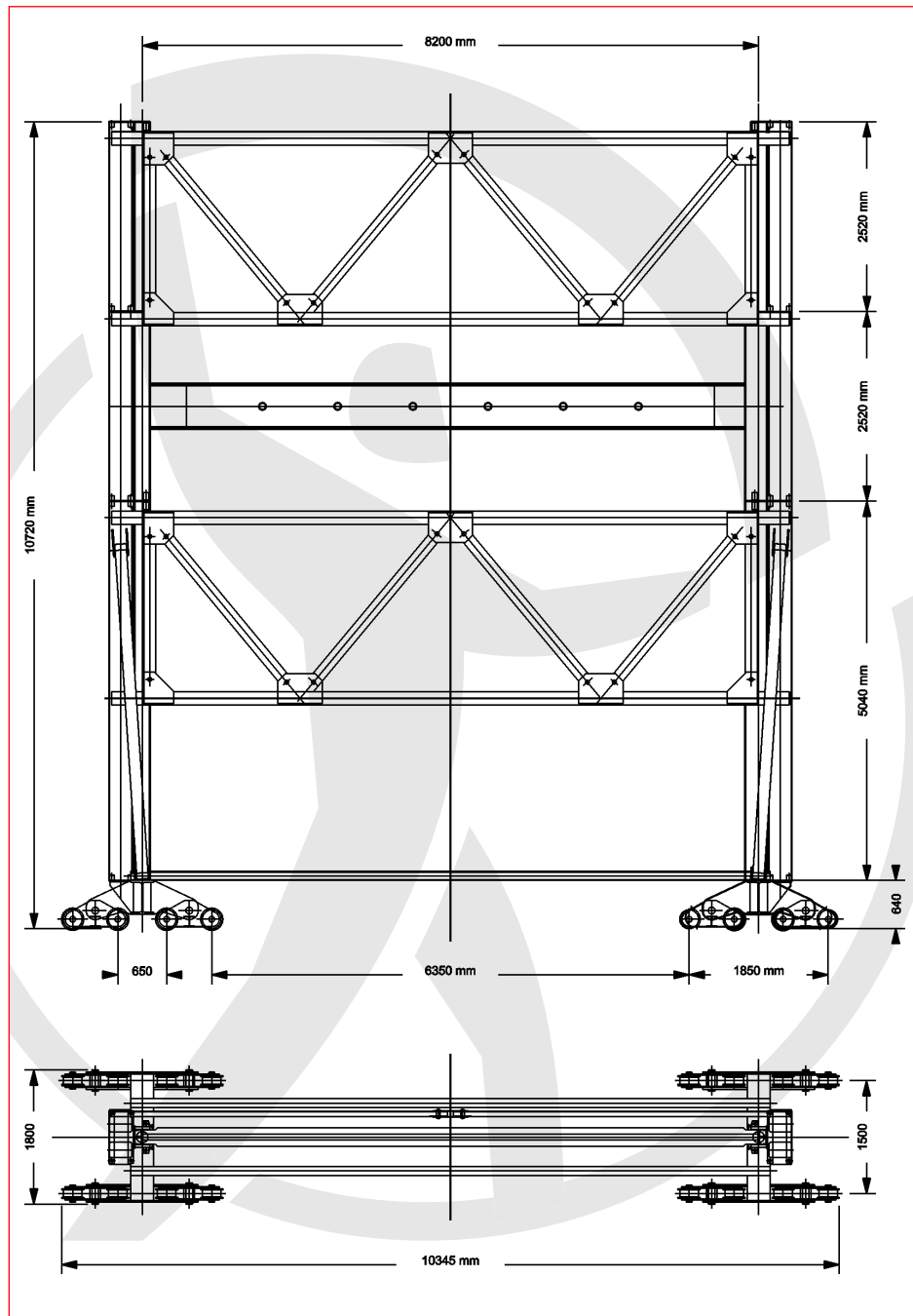

Stand 2007

